

ecoglo® | VISIBLY BETTER 24 HOUR STEP EDGE CONTRAST

Using advanced photoluminescent and non-slip technology Ecoglo products help people negotiate life's hazards.









Installed worldwide, Ecoglo has many raving fans whose patrons are getting safely and easily to where they need to go. Why? Because Ecoglo products are Rough, Tough, Seen and Green!



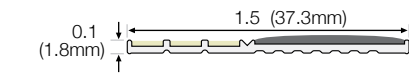
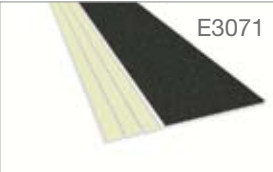

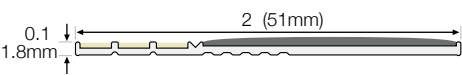

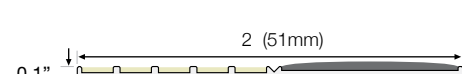

***We Never Miss a Step
Neither Will You***

www.ecoglo.ca



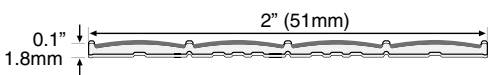

E SERIES CONTRAST STRIPS

 E2071	 E2061	 E2051	 0.1 (1.8mm) ↑ 1.5 (37.3mm) →
 E3071	 E3061	 E3051	 0.1 (1.8mm) ↑ 2 (51mm) →
 E4071	 E4061	 E4051	 0.1 (1.8mm) ↑ 2 (51mm) →

N SERIES NON-SLIP STRIPS

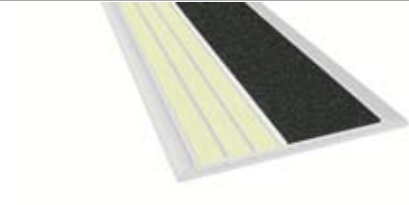
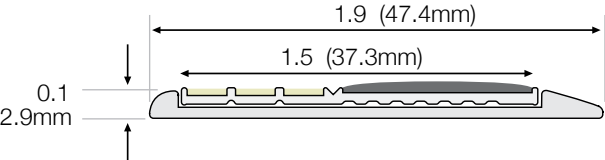
 N1070	 N1060	 N1050	 0.1 (1.8mm) ↑ 2" (51mm) →
 N2070	 N2060	 N2050	 0.1 (1.8mm) ↑ 1.5" (37.3mm) →

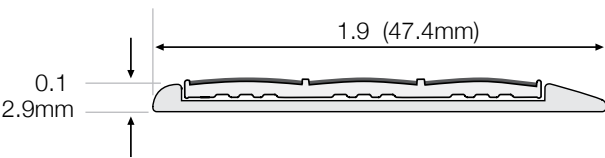
THRESHOLDS

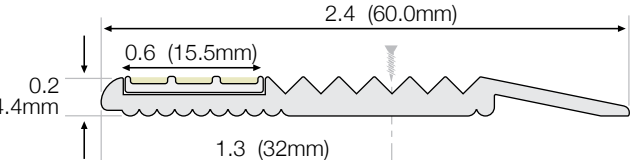
	<p>Black Non-Slip - T3171 Grey Non-Slip - T3161 Yellow Non-Slip - T3151</p>	 0.1 (2.9mm) ↑ 1.5 (37.3mm) → 1.9 (47.4mm) →
	<p>Black Non-Slip - T3170 Grey Non-Slip - T3160 Yellow Non-Slip - T3150</p>	 0.1 (2.9mm) ↑ 1.9 (47.4mm) →
	T4101	 0.2 (4.4mm) ↑ 0.6 (15.5mm) → 1.3 (32mm) → 2.4 (60.0mm) →

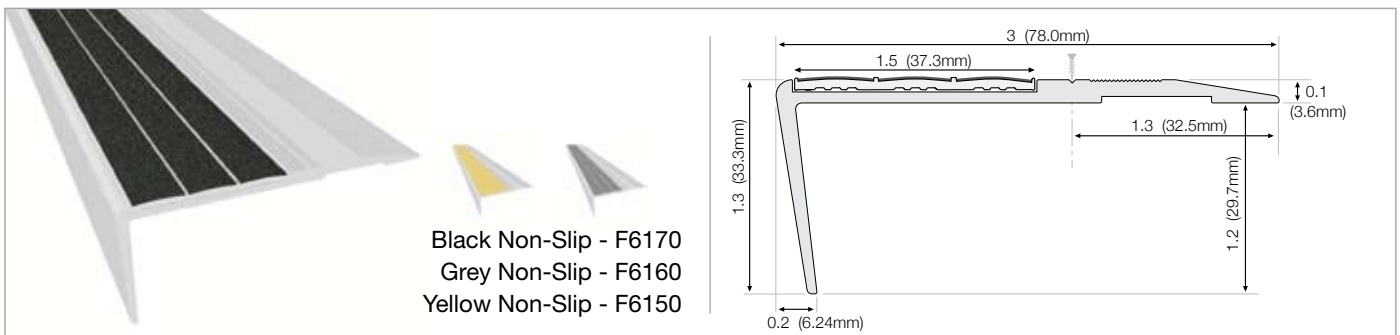
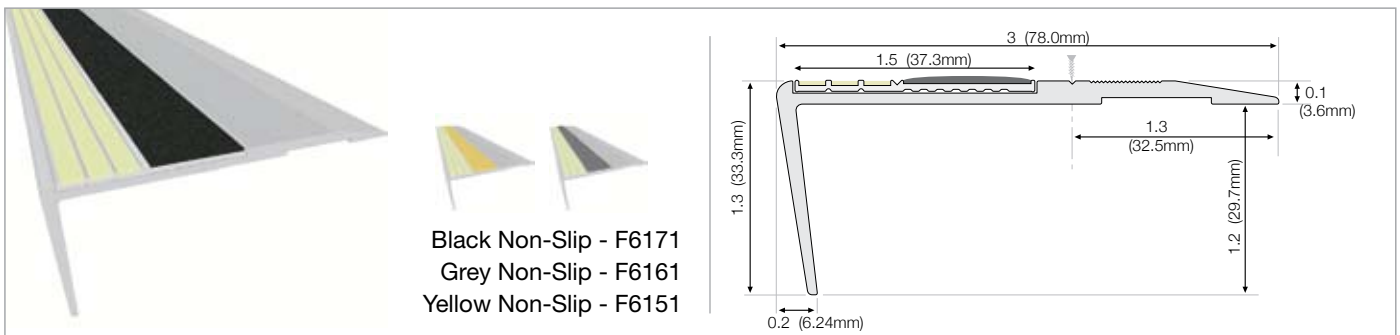
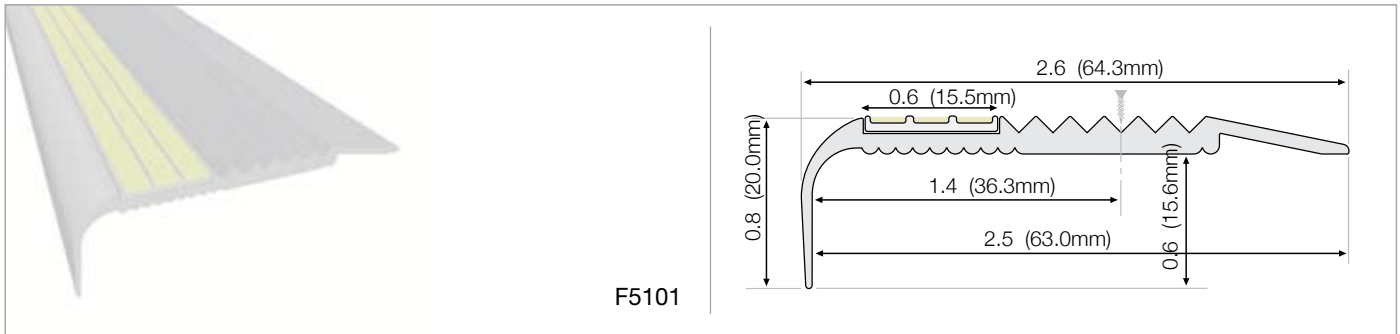
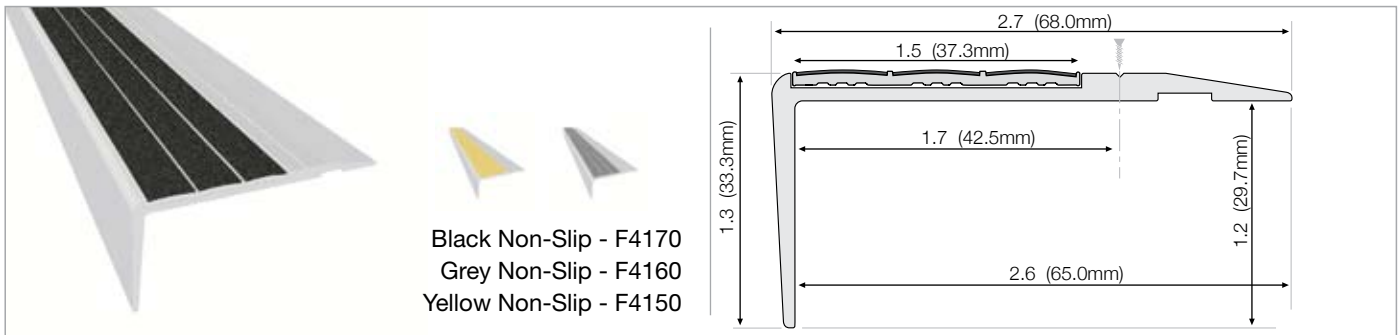
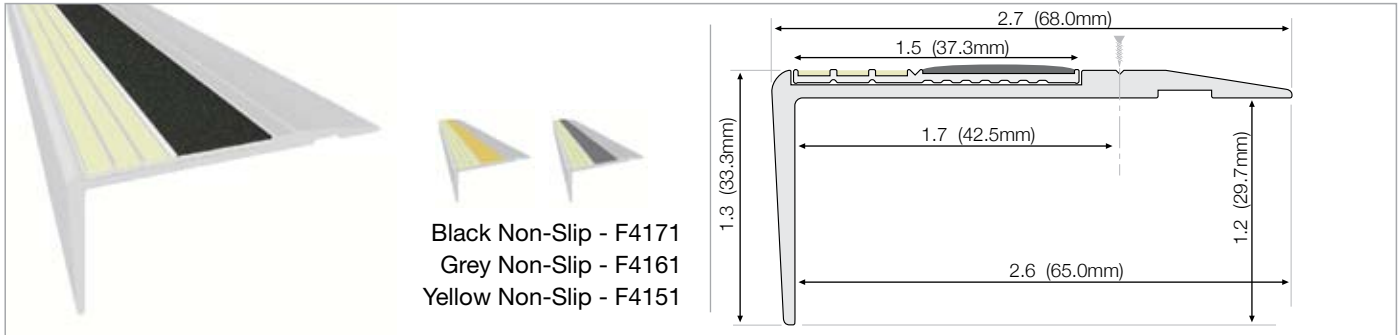

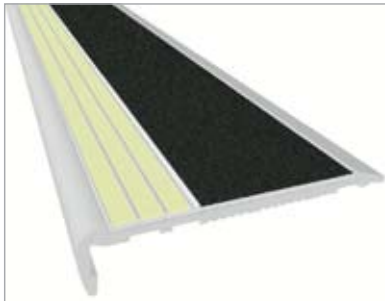

Black Non-Slip - F7171
 Grey Non-Slip - F7161
 Yellow Non-Slip - F7151

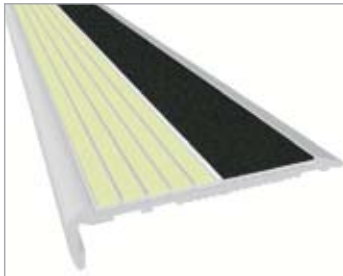
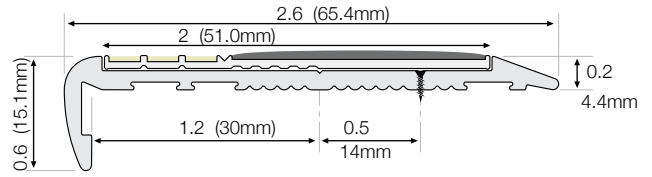

Black Non-Slip - FA7171
 Grey Non-Slip - FA7161
 Yellow Non-Slip - FA7151

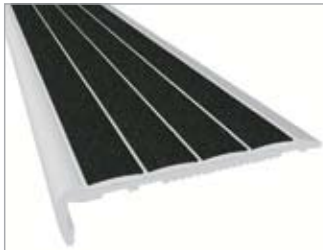
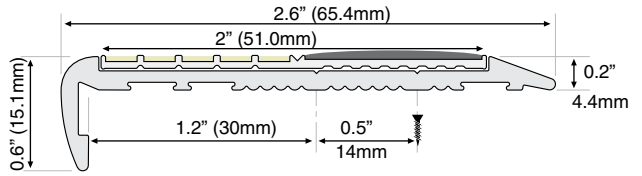

Black Non-Slip - F7170
 Grey Non-Slip - F7160
 Yellow Non-Slip - F7150

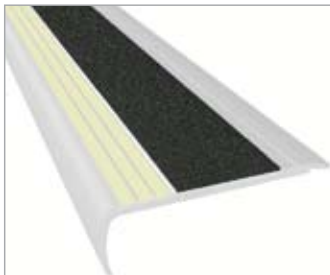
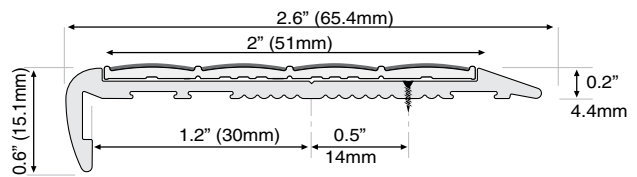

Black Non-Slip - F8171
 Grey Non-Slip - F8161
 Yellow Non-Slip - F8151

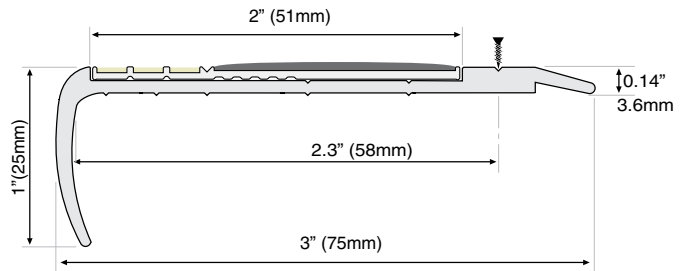

Black Non-Slip - FA8171
 Grey Non-Slip - FA8161
 Yellow Non-Slip - FA8151

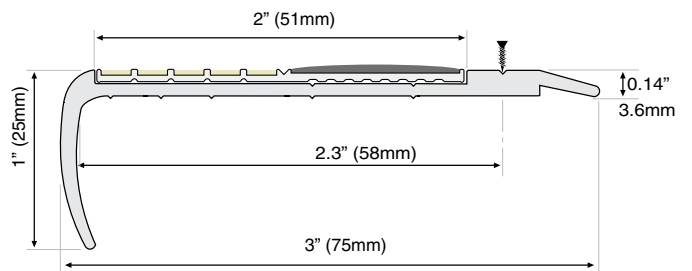

Black Non-Slip - F8170
 Grey Non-Slip - F8160
 Yellow Non-Slip - F8150

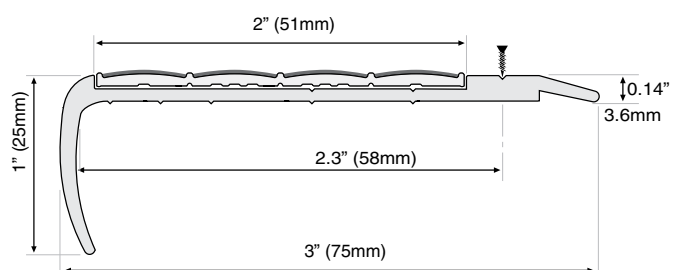

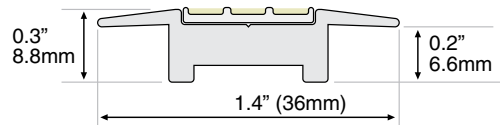
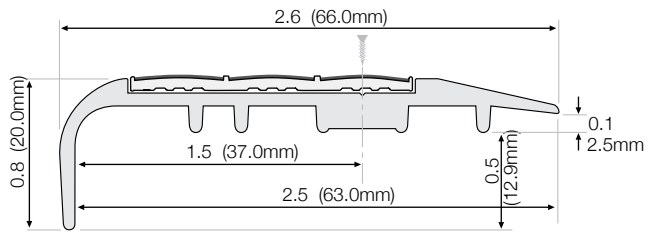
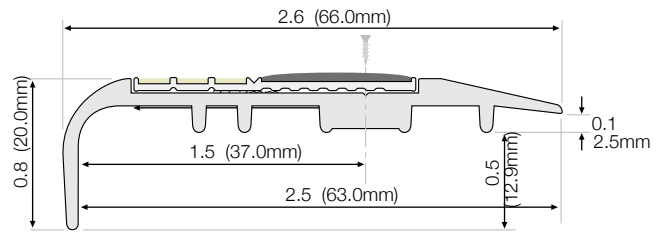
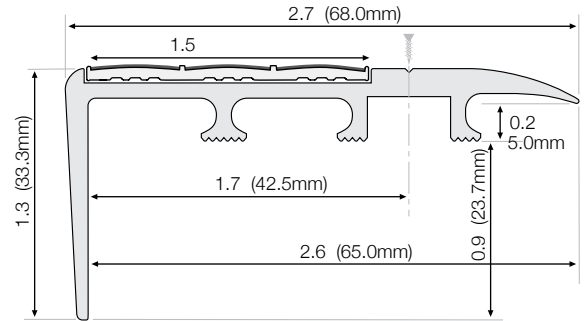
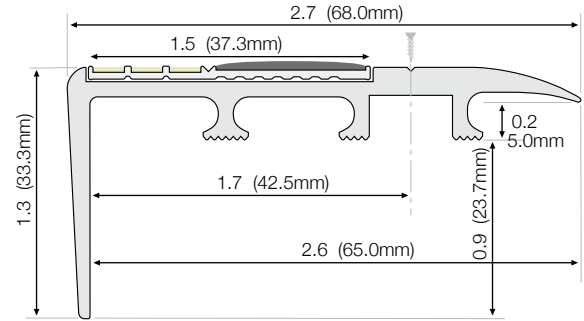

G SERIES GUIDANCE STRIPS

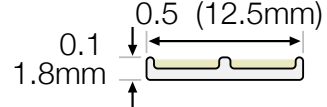

G3001

G4001



G6001

H SERIES HANDRAIL STRIPS



H5001



H3001

SIGNAGE

EGRESS

① 7.9" x 3.9" ② 3.9" x 3.9"



Exit EX2010



Emergency Exit Only EE2010

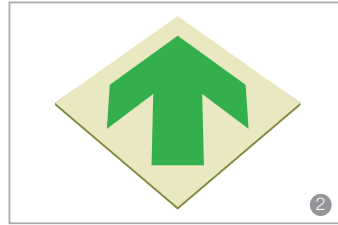

Arrow AR1010H & AR1010D



Running Man RM1010

EMERGENCY

② 3.9" x 3.9"



Fire Alarm FA1010



Fire Extinguisher FE1010



Fire Hose FH1010

AISLE MARKERS

③ 2.6" x 1.8" ④ 1.8" x 1.3" ⑤ 3.5" x 3.5" ⑥ 1.5" x 6" ⑦ 2.4" diameter ⑧ 2.7" diameter



RE65/45 & RE45/32.5

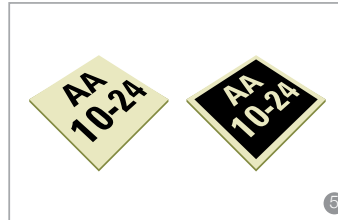

SQ88/88

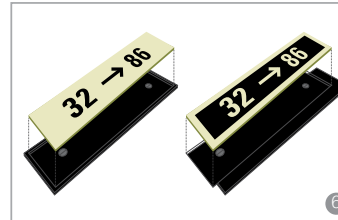

RE38/151 (holder available separately)

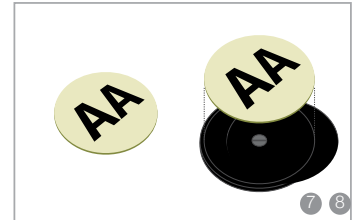

DS60 & DS68 (holder available separately)

SEAT NUMBERS

⑨ 1.3" x 1.3" ⑩ 1.6" diameter ⑪ 0.7" x 2.2" ⑫ 0.6" x 1.1" ⑬ 0.6" x 1.8"



SQ31.9r



DS40

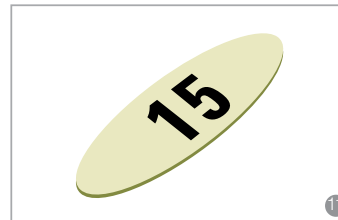

EL18.7/56.7

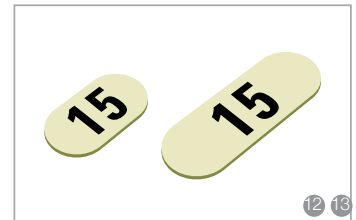

OR14.7/27.2 & OR16/44.6

MARKERS



Hazard Indicator OB82025

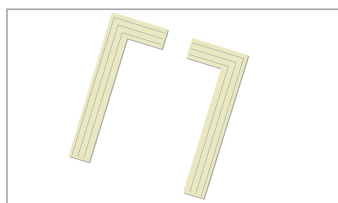

Edge Marker G6001L

no ecoglo lights on

ecoglo lights on

ecoglo lights off

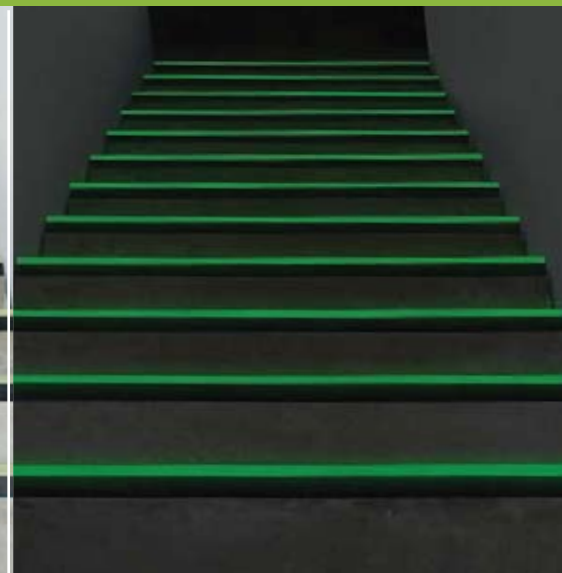

How the Ecoglo System Works

Ecoglo uses a patented process to produce a range of products that provide a four pronged solution to path finding needs:

- Step-edge contrast
- Slip-resistance
- Visibility in all light conditions
- Resistance to wear

ROUGH

The hard-wearing silicon carbide non-slip material is just what you need to reduce slips and falls in all weather conditions. Your patrons will commend you, not complain to you.

With their UV resistance and good looks, you can confidently install Ecoglo products inside and out.

TOUGH

Our patented process bakes in the photoluminescent powder and non-slip material and you get to savor the results. Thousands of people can walk on these products thousands of times with no wear and tear. And just to make sure, we've put them through extensive testing at internationally accredited laboratories relating to durability, weather resistance, UV resistance, stain resistance, abrasion and cleaning. And they passed with flying colors.

SEEN

Unlike electrical or battery lighting, Ecoglo products will never let you down. They will glow brightly in the dark for many hours giving your patrons confidence in exiting, even in an emergency. Some steps are just too hard to see, whether it be day or night. With Ecoglo, you can be sure your patrons will see the steps, not fall down them, whatever the light conditions. It's the combination of the photoluminescent strip and the non-slip material that creates such great step edge definition.

GREEN

Every small step you take to reduce electricity usage helps save our environment. Ecoglo products let you recycle natural sunlight or artificial light. No electricity is required. Ecoglo also goes green by using recycled aluminum. All products are non-toxic and non-radioactive. Designed to last the life of your facility, Ecoglo avoids maintenance costs. Ultimately, Ecoglo is recyclable which avoids the cost of landfill dumping.

Code References for Photoluminescent Exit Path Markers

- 2009 IFC Exit Lighting, January 2009
- 2009 IBC Section 1027, January 2009
- NFPA 101 and 5000, January 2009
- California, Chapter 10, January 2008
- Connecticut, Section 1026, January 2008
- New York City Code, July 2008
- GSA Buildings, January 2009
- British & ISO Standards for PL Brightness
- Tokyo Fire Department
- Japan Fire & Disaster Management Agency
- Building Code of Australia
- New Zealand Building Code

Ecoglo Strengths	Deliver Real Benefits.
High quality anti-slip material.	Reduces slips and fall.
High quality photoluminescence.	Visible for hours in dark conditions.
Heat bonding process.	Hardwearing, no repainting.
Step edge contrast.	Reduces falls in daylight and night time conditions.
Recycles natural or artificial light.	Decreases electricity usage, increases sustainability.
Ultraviolet resistance.	Can be installed inside or out
Internationally accredited testing.	Specify with confidence.

24 HOUR STEP EDGE CONTRAST

ENGINEERED PLASTICS INCORPORATED
 1400 Cornwall Road, Unit 6
 Oakville, Ontario, L6J 7W5.
 Tel: 888-679-4022
 Fax: 877-679-4022

www.ecoglo.ca